

AUTOMOTIVE INDUSTRY PROFILES

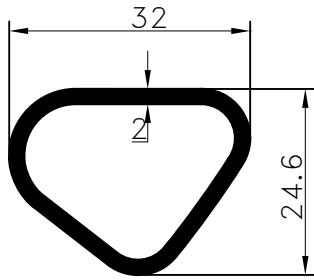

Pr.No: 8090
0,451 kg/m

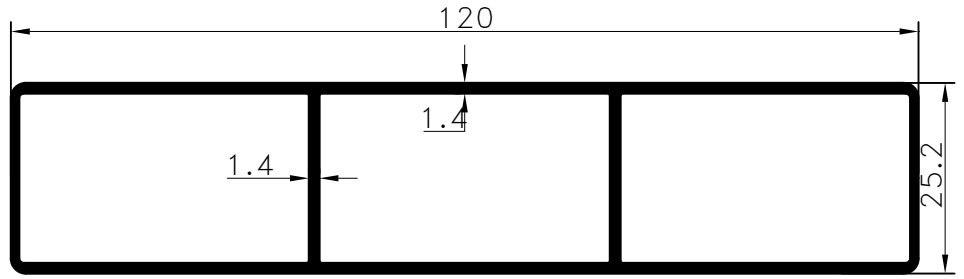

Pr.No: 8972
1,206 kg/m

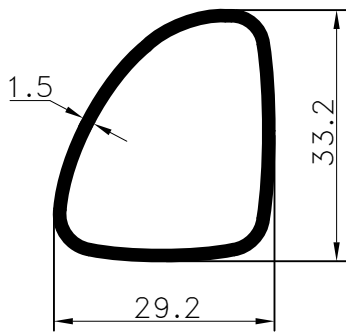

Pr.No: 8627
0,403 kg/m

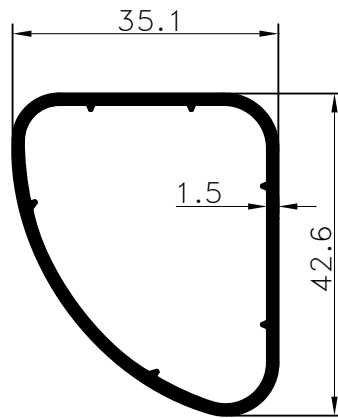

Pr.No: 8610
0,525 kg/m

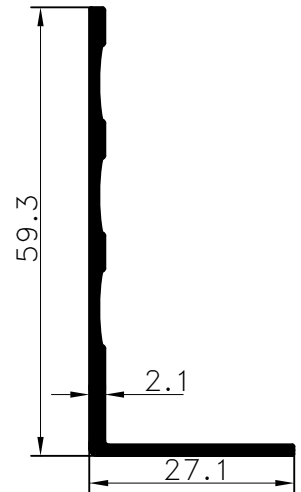

Pr.No: 9194
0,372 kg/m

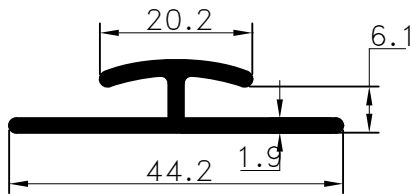

Pr.No: 9196
0,366 kg/m

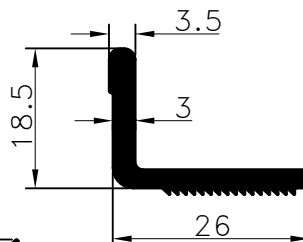

Pr.No: 9000
0,334 kg/m

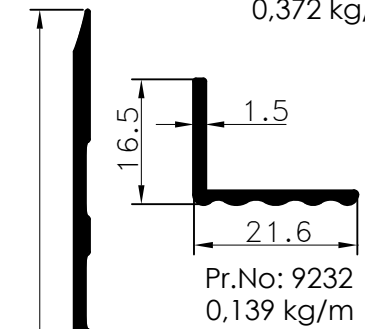

Pr.No: 9232
0,139 kg/m

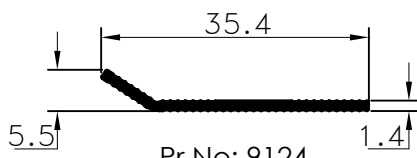

Pr.No: 9124
0,127 kg/m

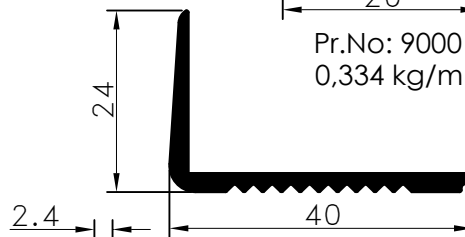

Pr.No: 9147
0,336 kg/m

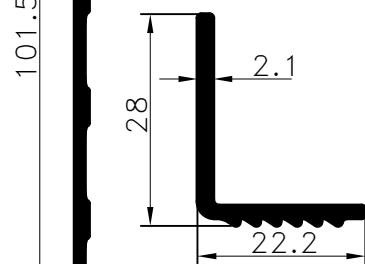

Pr.No: 9233
0,266 kg/m

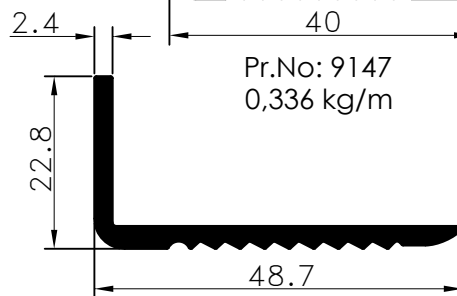

Pr.No: 9378
0,453 kg/m

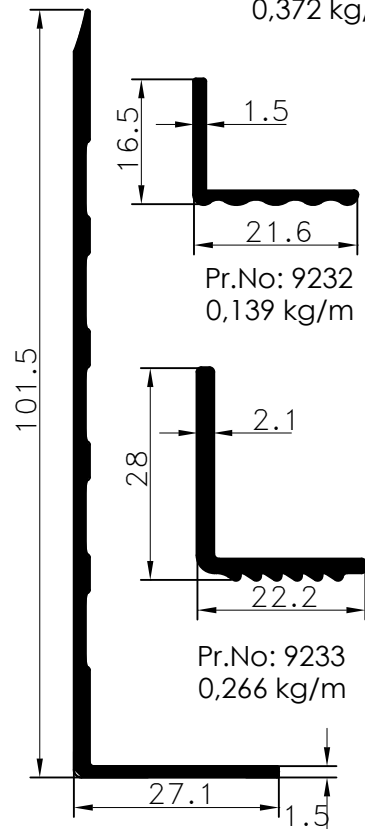

Pr.No: 8765
0,574 kg/m

AUTOMOTIVE INDUSTRY PROFILES

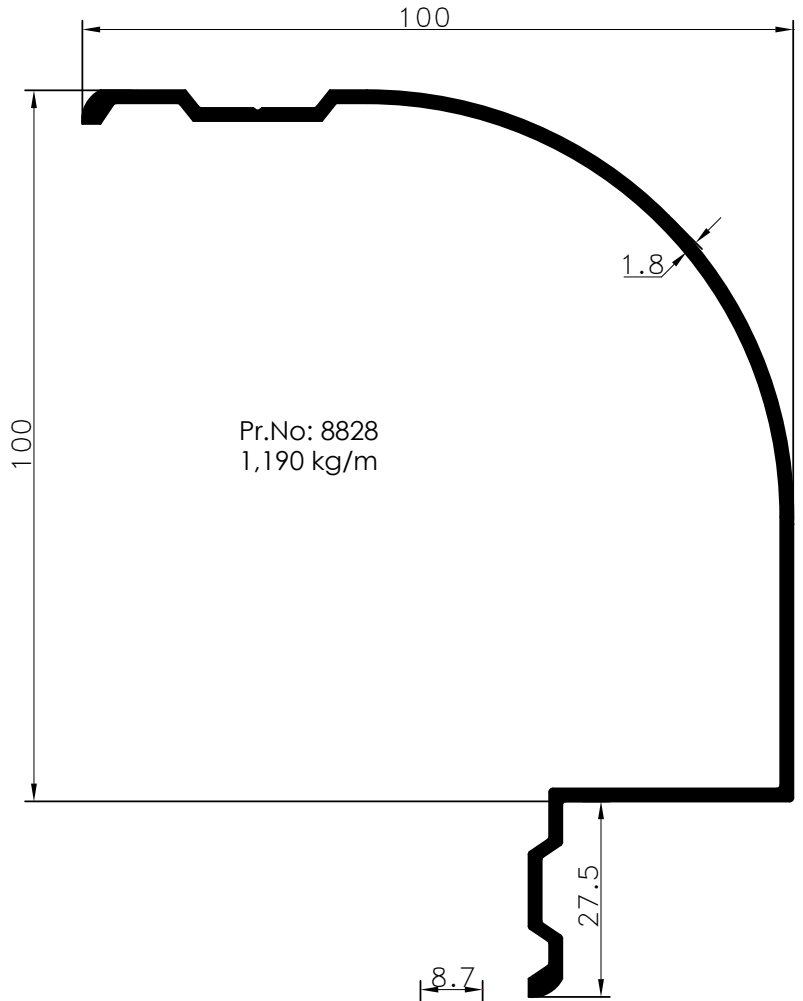
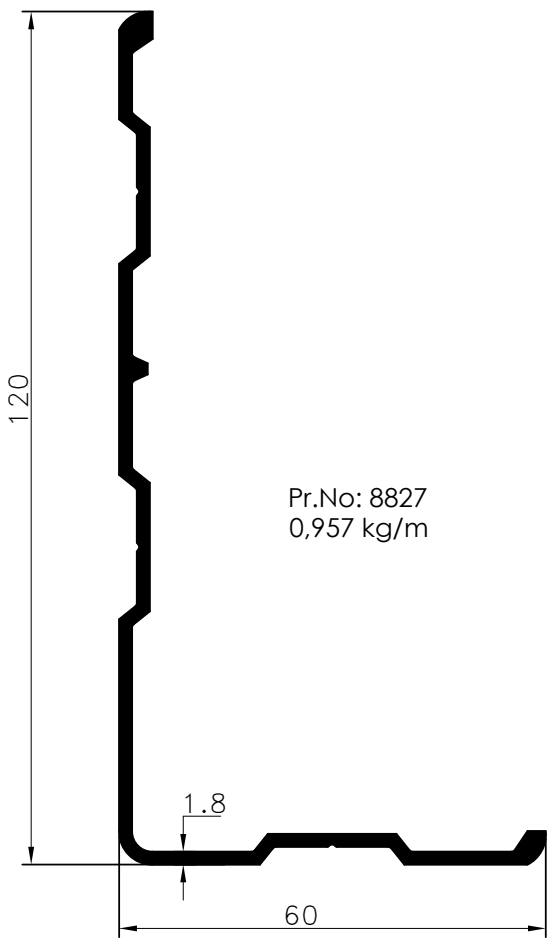

Pr.No: 8947
0,214 kg/m
ÖZEL/PRIVATE

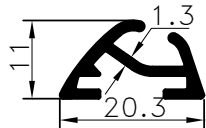

Pr.No: 8948
0,179 kg/m
ÖZEL/PRIVATE

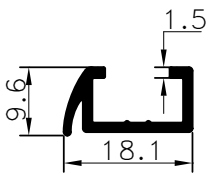
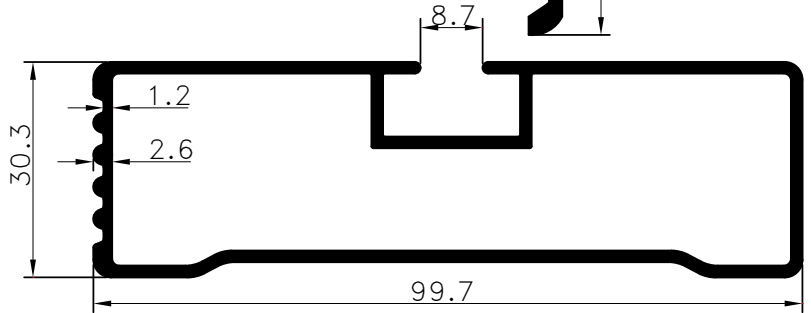

Pr.No: 8946
0,148 kg/m
ÖZEL/PRIVATE

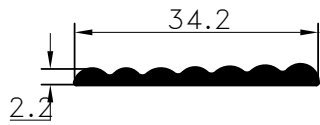

Pr.No: 9230
0,184 kg/m

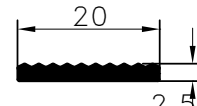

Pr.No: 9123
0,121 kg/m

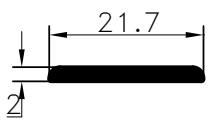

Pr.No: 9231
0,115 kg/m

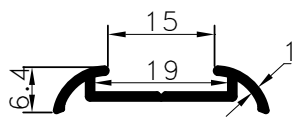

Pr.No: 9277
0,121 kg/m

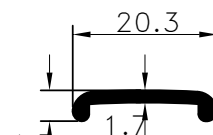

Pr.No: 9197
0,112 kg/m

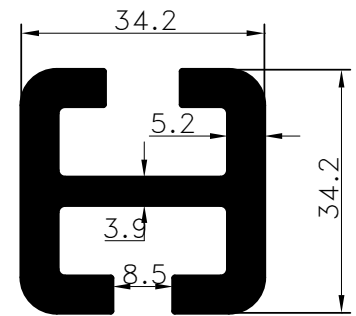

AUTOMOTIVE INDUSTRY PROFILES

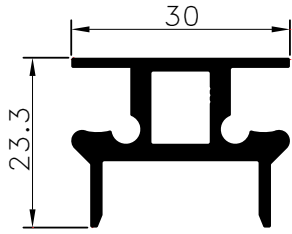

Pr.No: 9313
0,585 kg/m
ÖZEL/PRIVATE

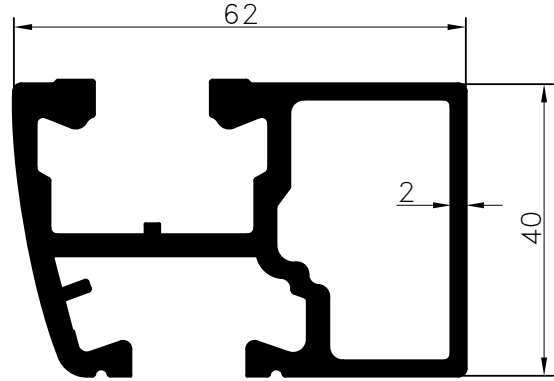

Pr.No: 9314
1,722 kg/m
ÖZEL/PRIVATE

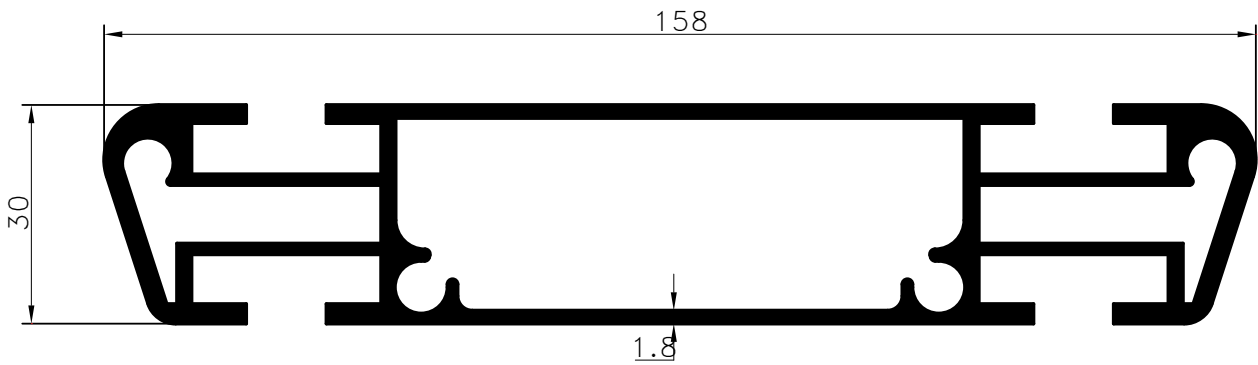

Pr.No: 9315
2,877 kg/m
ÖZEL/PRIVATE

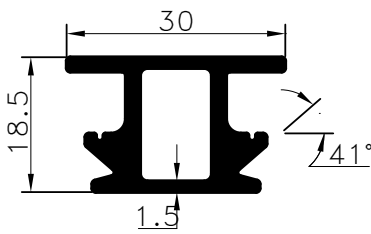

Pr.No: 9362
0,542 kg/m
ÖZEL/PRIVATE

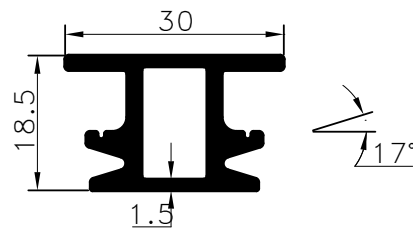

Pr.No: 9363
0,514 kg/m
ÖZEL/PRIVATE

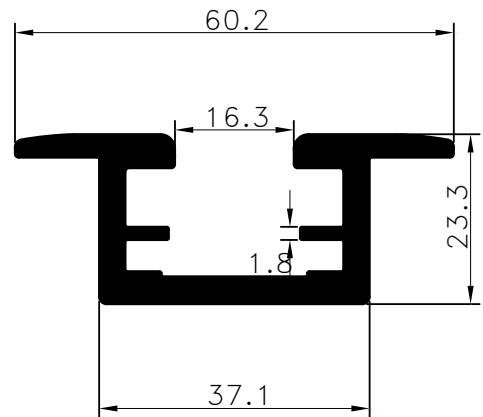

Pr.No: 9404
1,190 kg/m
ÖZEL/PRIVATE

AUTOMOTIVE INDUSTRY PROFILES

